

elb-15-02-03.pdf

by master 20

Submission date: 22-Jan-2024 09:04AM (UTC+0700)

Submission ID: 2275400866

File name: elb-15-02-03.pdf (351K)

Word count: 4086

Character count: 21546

REFERENCE PHOTOVOLTAIC (PV) MODEL BASED MAXIMUM POWER POINT TRACKING CONTROL SYSTEMS WITH ARTIFICIAL NEURAL NETWORK

YUNITA ARUM SARI¹, ASMINAR², PUTRI AISYAH KURNIA¹, SRI MAWAR SAID¹
DEWIANI¹ AND SYAFARUDDIN^{1,*}

¹Department of Electrical Engineering
Universitas Hasanuddin

Jl. Poros malino Km. 6 Bontomarannu, Gowa, Sulawesi Selatan 92127, Indonesia
Yunita.arumsari@cimbniaga.co.id; kurniapa23d@student.unhas.ac.id

{ srimawarsaid; dewiani }@unhas.ac.id

*Corresponding author: syafaruddin@unhas.ac.id

²Department of Electrical Engineering
Universitas Halu Oleo

Kampus Hijau Bumi Tridharma Anduonohu, Jl. HEA Mokodompit Kendari
Sulawesi Tenggara 93232, Indonesia
asminar.ft@uho.ac.id

Received April 2023; accepted July 2023

ABSTRACT. Irradiance and temperature have a considerable influence on photovoltaic (PV) performances. The PV properties and position of the array's optimal operating point (MPP) vary when a tiny section of a solar array is shaded. In this condition, traditional control algorithms just follow the local peak power point and are incapable of extracting the maximum power from the PV array. Due to variations in optimal output power and voltage from the local maximum point, a partially shaded PV array might cause the maximum power point controller to fail. The precise optimal voltage should be given as the reference for the controller-based voltage to improve control responses on the variations in operational voltage. The intelligent system based multi-layer perceptron neural network is used in this study to identify the ideal output power, and the optimum voltage is easily obtained by dividing the optimum output power by the PV array's load current. This paper presents a control technique to address the shading issues. Because it does not require knowledge of internal system characteristics, the dynamic PV model performance is supported using a neural network. The neural network is fed from daily data collections of the average sunlight intensity on selected panels. The optimal power and voltage were successfully simulated in various linked PV array topologies.

Keywords: Solar panel systems, Three-layered feed-forward network, Shading patterns, PV topologies, Performance index

1. **Introduction.** The increase in energy demand and environmental problems globally motivates the improvement research and development activities in renewable energy sources. Photovoltaic (PV) power is currently considered to be a renewable energy source and it generates electricity by the direct conversion of the sun's energy. A great deal of research has been supported in this field over the last few decades [1,2]. As a result, there are still open challenges to enhance the quality indicators of PV systems of reliability and efficiency and to reduce the operational and maintenance costs. One of the opportunities is to obtain much more power output of systems in overall weather conditions including the partial shading conditions when reduced irradiance is absorbed by some modules of PV array. The optimal output power and voltage will be highly useful knowledge in the future to implement in many research projects. The optimal output power can be utilized

DOI: 10.24507/icicelb.15.02.129

to predict the power/energy production of solar panels, whilst the optimal voltage might be utilized to create a voltage control signal for maximum power point management.

The mathematical modelling of the solar module's output characteristic is non-linear, and its output power characteristic is convex; therefore, artificial intelligence rules for the maximum power point may be simply developed as control algorithms. One method based on artificial intelligence is an artificial neural network (ANN). The ANN method has become an attractive option in solving estimation and optimization in engineering problems. The advantages of this method compared to conventional computational methods are simple and it has good pattern recognition capabilities [3,4]. By using the ANN method, the internal knowledge parameter of a system is no longer needed, the computational process is fairly enough and the method can be used to solve multi-objective problems [5]. In some cases, it only takes the data training process to get the optimal solution without solving non-linear mathematical equations or making statistical assumptions as commonly used in conventional optimization methods [6]. Therefore, the ANN technique has proven to be suitable for system modeling, process identification, optimization, prediction, forecasting and control of complex systems.

Because the power and energy production of solar panels are variable owing to fluctuations in sunlight intensity and ambient temperature, their output power and energy should be estimated. The artificial neural network method has been intensively used to track the maximum point of a photovoltaic system. The three-layered feed-forward neural network (TFFN) type is very simple to utilize as the fault diagnosis and classification methods considering multi-output tasks [7,8]. However, this multi-layer perceptron (MLP) structure is sometimes constrained by slow computational efforts during the training process. Despite the fact, the TFFN structure is the most popular structure among all artificial neural network structures used for the optimization of photovoltaic systems. In order to maximize the performance of the TFFN structure in relation to achieving the convergence level during the training process, the selection of data for the training process is important. Meanwhile, the radial basis function (RBF) method is used for controller reference in maximum power point tracking applications of solar pumping systems [9]. For the efficient technique, the RBF structure can be used to determine the output efficiency and maximum power point tracking control of photovoltaic systems [10]. In terms of the adaptive neuro-fuzzy inference system structure, it seems that it is rarely used for optimization processes in photovoltaic system applications, except for one study that attempted to carry out a training process to determine the estimated sunlight intensity and ambient temperature [11]. In terms of real-time modeling and simulation, artificial neural networks have been considered an established method to evaluate the performance of high-scale of grid connected solar panels [12]. All of the above facts show that the artificial neural network method is still quite interesting to be developed for the process of control and optimizing output of photovoltaic systems.

The goal of this study is to use the ANN approach to calculate the optimal power point of a PV array under shading conditions. One of the current problems in the non-uniform sunlight intensity conditions is the decreasing performance of power tracking control to enhance the output energy conversion of solar panel operation. The performance designed control is mostly operating around the local maximum point; however, they fail to detect the shifting point during shading conditions. By promoting the optimal voltage as the voltage reference via artificial neural network approach, it drives the controller to perform control signal around the optimum voltage. In this research, the optimal output power is determined directly from the ANN output, but the optimum voltage is produced by dividing the optimum power by the load current of the PV array. This procedure is incredibly easy because no additional equipment is required. The findings of the proposed method can help to improve the controller performance to the point near the optimal voltage in overall environmental conditions.

The article is organized as follows. The literature and critical reviews about the utilization of artificial neural network as one of the popular techniques for the estimation and prediction of output parameters of PV systems are consecutively explained with recent references in Section 1. Then, the benchmarking of our proposed method with different PV array connections and proposed artificial neural network is presented in Section 2. The following Section 3 outlines the control performance of the proposed method including the discussion for different scenarios. Finally, the conclusion of this study is given in Section 4 with the summary of important results and the stated potential further study.

2. Benchmarks of Proposed System. PV modules are constructed in different configuration of array of photovoltaic cells with a maximum power point (MPP). In Figure 1, the proposed system comprises solar panel model and neural network structures. The input signals are the irradiance intensity (E_m) in W/m^2 and the temperature of cell (T_c) in degrees Celsius, while the output terminal may monitor three dc output parameters: V_{dc} , I_{dc} , and P_{dc} . Only the power at maximum power point is chosen as the goal output from the ANN block in order to fulfil the optimal output power (P_{dc}^*) as a function of E_m and T_c during the neural network training process. Another goal of this research is to determine the optimal voltage (V_{dc}^*), which can be calculated by simply dividing the optimum output power by the load current. The optimal output power (P_{dc}^*) and voltage (V_{dc}^*) are highly useful information for determining the estimated output power of PV systems and the reference of voltage for maximum power point regulation, respectively.

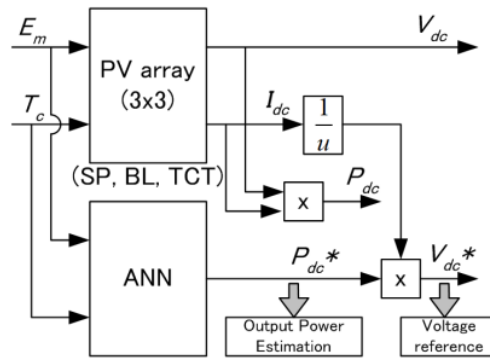

FIGURE 1. Schematic diagram of the proposed systems

2.1. Configuration of PV systems. The PV array is made up of 3×3 mono-crystalline Silicon modules with connections of SP, BL and TCT. The technical benefit of this solar module is the capacity to provide high energy conversion performance in low sunlight intensity by structured pyramidal textured surface. Table 1 shows the electrical specifications of this module under regular test conditions.

TABLE 1. Electrical data of mono-crystalline Silicon modules

Current at maximum power point (I_{mpp})	3.15 A
Voltage at maximum power point (V_{mpp})	17.4 V
Short-circuit current (I_{sc})	3.45 A
Open-circuit voltage (V_{oc})	21.7 V
Power at maximum power point (P_{mpp})	55 W
STC: AM function = 1.5; $E_o = 1000 W/m^2$; $T_o = 25^\circ C$	

According to the previous study, the PV array model may be built using three alternative connections, i.e., SP, BL, and TCT [7,8]. Figure 2 depicts these linked arrays. In series connected solar panels and they are shaded; the shaded panels will prevent and compel the produced current of the normal panels to follow the shaded ones. Current routes are constructed by attaching extra wires to the module connection, and the output current of non-shaded panels flows to the output terminal. Large amount of power is expected to be extracted when panels are shaded. However, the approach is only applicable in limited situations. For example, if just M1 is shaded, the BL and TCT connections can still send much output power. When modules M1 and M2 receive less intensity of sunlight, only the TCT connection can transmit significant power output. When the M1 to M3 are shaded, there are significant impacts of connection to the power losses because the shaded modules are blocking the output power from the non-shaded ones.

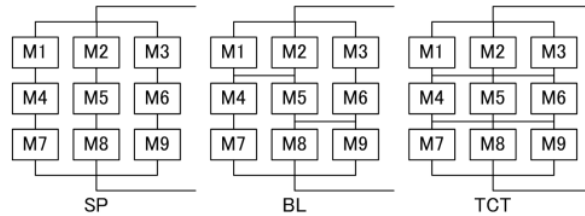

FIGURE 2. Different PV array topologies

In this study, the created PV array input is changed for connection to the ANN block. Normally, pyranometers are used to measure both the irradiance level and the cell temperature in each module. Only four sets of pyranometers are employed to measure the average of incoming irradiance level (E_m) on selected modules to limit the amount of equipment. In the case of cell temperature, it is fixed to be constant at 50°C since the temperature of solar panel increases to significant level above the surrounded temperature with extremely modest variations in normal solar panel operation. Figure 3 depicts the adjustment of the measured irradiance level.

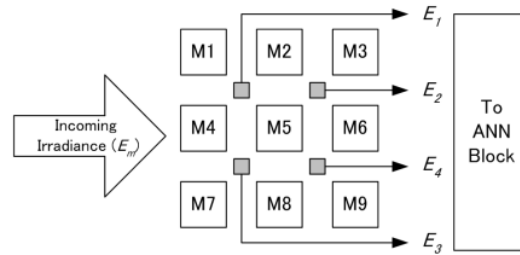

FIGURE 3. Modification of irradiance measurement for ANN input

In Figure 3, E_1 , E_2 , E_3 , and E_4 are the averages of the incoming irradiance levels on the modules (M1, M2, M4, M5), (M2, M3, M5, M6), (M4, M5, M7, M8), and (M5, M6, M8, M9), respectively.

2.2. Configuration of artificial neural network. Because of its strong pattern recognition capability, ANN has recently been used as an estimating approach in a variety of engineering domains. In this case, multi-layer perceptron neural network as shown in Figure 4 is used to compute the estimated power (P_{dc}^*) of solar panels: an input, a hidden layer, and an output layer. The input layer is made up of nodes for the average irradiance levels E_1 , E_2 , E_3 , and E_4 , as well as a bias signal of 1.0. The average irradiation is taken

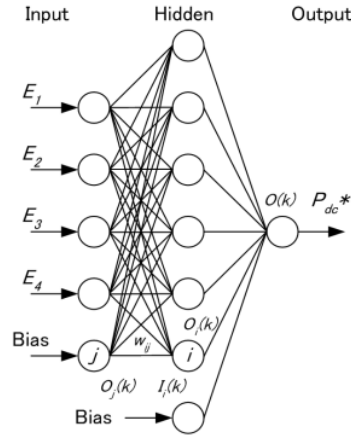

FIGURE 4. The ANN configuration

from normal irradiance measurements from 6:00 a.m. to 6:00 p.m. The number of nodes in the hidden layer is determined by the training process's minimal error. The predicted output power is provided by the output layer.

For the reference PV model, different network sizes have been implemented by varying the number of nodes and hidden layers. The optimum network is realized with three-layer feed-forward neural network with sigmoid activation function. The input layer has 4 nodes, the hidden layer has 11 nodes, and the output layer has 1 node. The input layer in this case consists of a four-dimensional vector of irradiance profiles and the output vector is single dimensional vector of power at maximum power point of PV array. All data are scaled down to the range $\{-1; 1\}$. The learning stage of the network is performed by updating the weights and biases using conjugate gradient back propagation. With the proposed neural network model, the PV equivalent circuit parameters can be determined easily using the irradiance profile signal as input without knowing any other physical parameters. Then these parameters are used in the plant PV model.

The sigmoid function is used for the input-output properties of the nodes in the hidden layer. The output $O_i(k)$ for each node i in the hidden and output layers is as follows [13]:

$$O_i(k) = \frac{1}{1 + e^{-I_i(k)}} \quad (1)$$

In Equation (1), $I_i(k)$ denotes the input signal to node i at the k th sample. The weighted sum of the input nodes yields the input $I_i(k)$ as follows:

$$I_i(k) = \sum_j w_{ij}(k)O_j(k) \quad (2)$$

where w_{ij} is the weight of the link from node j to node i and $O_j(k)$ denotes the output from node j .

The training process is conducted to precisely determine the optimal output power and the connection weights w_{ij} must be computed using common patterns. The pattern of input-output for training process is quite necessary. During training process, the weights w_{ij} are iteratively tweaked until the best vector for the matching of input-output data is attained based on the minimum value of the sum of the squared errors (E) which is calculated as follows:

$$E = \sum_{k=1}^N (t(k) - O(k))^2 \quad (3)$$

where N represents the total number of training patterns, $t(k)$ represents the k th target output from the output node, and $O(k)$ represents the calculated value. The connection weights w_{ij} are first set to random values. The error function is assessed for the patterns of data training, and the weights w_{ij} are modified to the minimum error in Equation (3).

Table 2 shows how the training data set for input-output was arbitrarily picked on three separate PV array connections based on criteria to improve learning data recognition. The power at maximum power point for the provided situation is the training process's target output. Due to these input-output constraints, there are approximately 370 of input-output data combination, which encompass uniform irradiance settings ranging from 100 to 1000 W/m². The learning and momentum rates are set to 0.2 and 0.85 during the training phase, respectively.

TABLE 2. Scenarios of training data set

Reference irradiance (W/m ²)	Arbitrary shaded patterns (W/m ²) on selected modules
1000	100; 200; 300; 400; 500; 600; 700; 800; 900
900	100; 200; 300; 400; 500; 600; 700; 800
800	100; 200; 300; 400; 500; 600; 700
700	100; 200; 300; 400; 500; 600
600	100; 200; 300; 400; 500
500	100; 200; 300; 400
400	100; 200; 300
300	100; 200
200	100

The total minimum error throughout the training procedure is used to determine the number of hidden nodes (n_h). When the number of hidden nodes is 11, the overall minimum errors for all connections of solar panel are about 0.03. It signifies that all connection weights w_{ij} have the same dimension. Because the additional wiring only distinguishes these connections, a single set of weights may be chosen to represent all connections following the index (J), which is stated as follows:

$$J = \int (P_{dc}^* - P_{dc})dt \tag{4}$$

where P_{dc}^* denotes the estimated optimal output power and P_{dc} denotes the actual output power. This index was generated using three alternative sets of weights on the irradiance variation displayed in Figure 5.

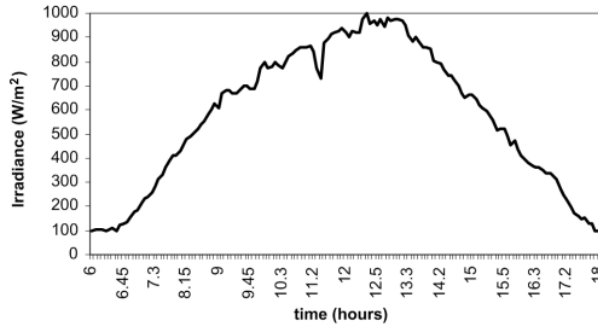

FIGURE 5. Typical one-day irradiance measurement

Table 3 shows the total outcomes of the training process. The weights acquired from the BL training data set might be used to represent the three PV array connections based on the index result. With a single group of weights, there is no longer any association between the kind of connection and the output characteristics of the PV array. Figure 6 depicts the simulation result of optimal output power and voltage by utilizing these weights in BL connection under normal irradiance conditions.

TABLE 3. Summary results of training process

Parameters	PV array connections		
	SP	BL	TCT
n_h	11	11	11
SSE	0.03191	0.032	0.0298
J	12.07	10.68	54.85

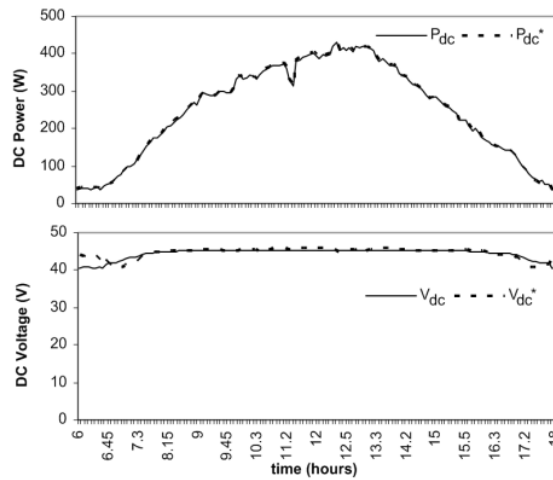

FIGURE 6. Performance of BL connection under normal conditions

3. Results of Controller Performance. The control outcomes will demonstrate the usefulness of the neural network method in determining the estimated power and voltage of solar panels under shading conditions. The technique can perform relatively accurately under different non-uniform irradiance conditions and a vast region of shade in solar panel configuration by employing a single set of weights as a consequence of the training process. The shading scenarios in this result were set arbitrarily from 10:00 a.m. to 15:00 p.m. as the peak time operating of the PV array with 25%, 50%, and 50% of light intensity entering the modules. The shading regions of arrays are also evaluated from small (1M), medium (5M), to large (8M).

The first result illustrates the performance of controller on the solar panel with series-parallel with 5 modules shaded. Because of the presence of about three maximum points, this shaded area of modules might be regarded one of the worst cases. Furthermore, with lower light intensities, the optimal voltage might drop to a lower level, reducing output power. If modules only get 25% of the maximum light intensity, the optimal voltage drops from 40V to 30V and the optimum output power drops by nearly 4 times. Figure 7 clearly shows that even with extensive shade, the best power and voltage conditions can be tracked although the voltage is shifting far away from the normal maximum point.

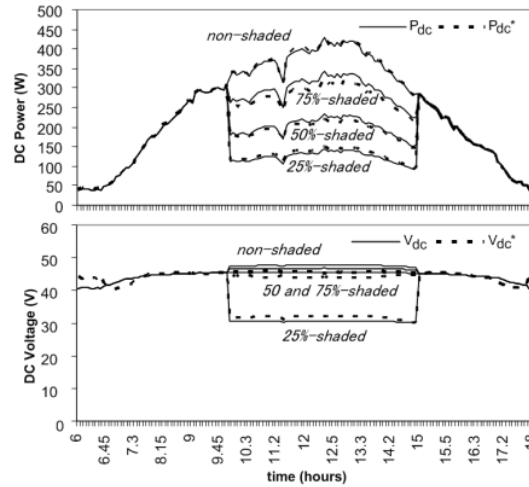

FIGURE 7. Performance of SP connection with 5 modules shading

In other scenarios, only M1 receives 25%, 50%, and 75% of the light intensity in a BL connection. Because just a tiny portion of the array is under shadow, this shading pattern is dubbed light shading. As a result, output power decreases less significantly while voltage remains at its local maximum. Figure 8 again demonstrates that the proposed technique may approach the best-fit power and voltage near the local maximum point.

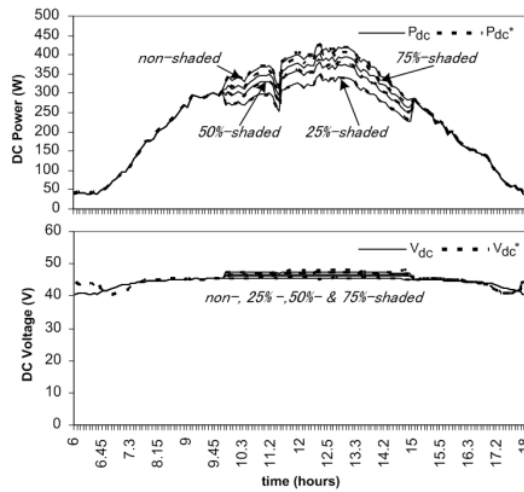

FIGURE 8. Performance of BL connection with 1 module shading

The controller performance on the total cross-tied connection is simulated with 8 modules shading. Despite the fact that this shading pattern is characterized as wide shading area, the reference voltage does not deviate from the local maximum point. In this case, only the output power is greatly lowered. It is because the PV array nearly always operates in a uniform irradiance state with extremely low light intensity. Figure 9 depicts the efficacy of the proposed method for determining the optimal output power and voltage under these conditions.

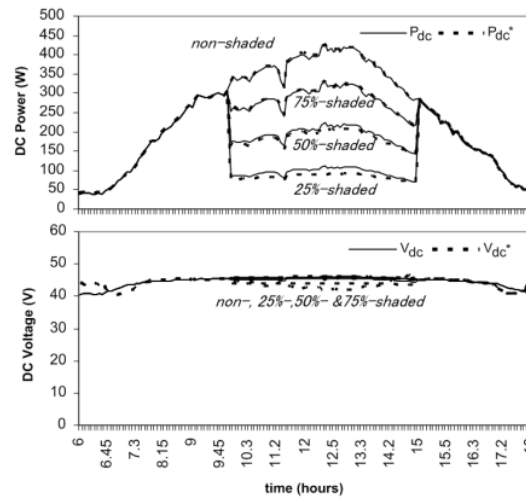

FIGURE 9. Performance of TCT connection with 8 modules shading

The implementation of our proposed method is noticeable when solar panels are grid-connected installation where daily, monthly, and annual projections are critical for planning the operation of the entire power grid. The predicted output power is particularly valuable in stand-alone and hybrid systems for optimal operation of balance of system components. Furthermore, the scheduled operation of various power plants may be carefully set for supply dependability and cost savings. Meanwhile, the prediction of energy output of solar panels might gain the significant revenue in solar energy project.

4. Conclusions. The optimal operating point of a PV array under partially shadowed conditions was determined using an artificial neural network (ANN) technique. The optimal output power is determined directly from the ANN output, but the optimum voltage is produced by dividing the optimal output power by the load current. Following the training procedure, a single set of weights is successfully acting on the PV array's SP, BL, and TCT connections. The study results have a number of implications, such as forecasting the power and energy output of solar panels and the readiness of voltage signal near the optimum voltage. Therefore, the findings of this study can help to improve the MPP control algorithms to the point where they perform properly in both uniform and non-uniform irradiance situations. For further study, the scheduling of various generation units in hybrid systems may be determined based on supply dependability and cost savings to gain the solar energy investment by using the precisely predicted output energy of PV arrays.

REFERENCES

- [1] Syafaruddin, Y. A. Sari and S. M. Said, A review of Building Integrated Photovoltaic-Thermal (BIPV/T) systems: Current and potential technology development, *Journal of Engineering Science and Technology Review*, vol.14, no.4, pp.197-206, 2021.
- [2] Syafaruddin, Gassing, F. A. Samman, N. Umniyah and F. Febriyana, Arduino UNO AVR ATmega328 microcontroller based dual axis solar tracker design, *ICIC Express Letters, Part B: Applications*, vol.13, no.4, pp.337-345, 2022.
- [3] A. Oulmelk, M. Srati, L. Afraites and A. Hadri, An artificial neural network approach to identify the parameter in a nonlinear subdiffusion model, *Communications in Nonlinear Science and Numerical Simulation*, vol.125, 107413, 2023.
- [4] H. Zhu, J. Liu, J. Yu and P. Yang, Artificial neural network-based predictive model for supersonic ejector in refrigeration system, *Case Studies in Thermal Engineering*, vol.49, 103313, 2023.

- [5] Y. Han, Y. Liao, X. Ma, X. Guo, C. Li and X. Liu, Analysis and prediction of the penetration of renewable energy in power systems using artificial neural network, *Renewable Energy*, vol.215, 118914, 2023.
- [6] H. H. Gul, E. Egrioglu and E. Bas, Statistical learning algorithms for dendritic neuron model artificial neural network based on sine cosine algorithm, *Information Sciences*, vol.629, pp.398-412, 2023.
- [7] S. Voutsinas, D. Karolidis, I. Voyiatzis and M. Samarakou, Development of a multi-output feed-forward neural network for fault detection in photovoltaic systems, *Energy Reports*, vol.8, no.2, pp.33-42, 2022.
- [8] A. N. N. Afifah, Indrabayu, A. Suyuti and Syafaruddin, A review on image processing techniques for damage detection on photovoltaic panels, *ICIC Express Letters*, vol.15, no.7, pp.779-790, 2021.
- [9] S. Chandra, P. Gaur and D. Pathak, Radial basis function neural network based maximum power point tracking for photovoltaic brushless DC motor connected water pumping system, *Computers & Electrical Engineering*, vol.86, 106730, 2020.
- [10] S. Chandra and P. Gaur, Radial basis function neural network technique for efficient maximum power point tracking in solar photo-voltaic system, *Procedia Computer Science*, vol.167, pp.2354-2363, 2020.
- [11] Syafaruddin, M. I. Abubakar, H. G. Soma, S. M. Said and S. Latief, Determination of sensorless input parameters of solar panel with adaptive neuro-fuzzy inference system (ANFIS) method, *International Journal of Innovative Computing, Information and Control*, vol.14, no.6, pp.2259-2271, 2018.
- [12] K. Narasimman et al., Modelling and real time performance evaluation of a 5 MW grid-connected solar photovoltaic plant using different artificial neural networks, *Energy Conversion and Management*, vol.279, 116767, 2023.
- [13] Syafaruddin, Gassing and F. A. Samman, Radial basis function and three-layered feed-forward network for the optimal output power of photovoltaic modules, *ICIC Express Letters*, vol.16, no.5, pp.555-562, 2022.

ORIGINALITY REPORT

16%

SIMILARITY INDEX

%

INTERNET SOURCES

16%

PUBLICATIONS

%

STUDENT PAPERS

PRIMARY SOURCES

- 1** Syafaruddin, , E. Karatepe, and T. Hiyama. "Artificial neural network-polar coordinated fuzzy controller based maximum power point tracking control under partially shaded conditions", IET Renewable Power Generation, 2009. 4%
Publication
- 2** Syafaruddin, Engin Karatepe, Takashi Hiyama. "ANN based Real-Time Estimation of Power Generation of Different PV Module Types", IEEJ Transactions on Power and Energy, 2009 1%
Publication
- 3** Engin Karatepe, Mutlu Boztepe, Metin Colak. "Neural network based solar cell model", Energy Conversion and Management, 2006 1%
Publication
- 4** T. Hiyama, S. Kouzuma, T. Imakubo. "Identification of optimal operating point of PV modules using neural network for real time maximum power tracking control", IEEE Transactions on Energy Conversion, 1995 1%
Publication

5

Yinlai Jiang, Shuoyu Wang, K. Ishida, T. Ando, M. G. Fujie. "Control of an omnidirectional walking support walker by forearm pressures", 2011 Annual International Conference of the IEEE Engineering in Medicine and Biology Society, 2011

Publication

1 %

6

Haixia Gong. "Uninterruptible power supply state of charge estimation based on BP neural network", 2020 The 8th International Conference on Information Technology: IoT and Smart City, 2020

Publication

1 %

7

Ahmed Refaat, Abd-Elwahab Khalifa, Mohamed Mohamed Elsakka, Yasser Elhenawy, Ahmed Kalas, Medhat Hegazy Elfar. "A novel metaheuristic MPPT technique based on enhanced autonomous group Particle Swarm Optimization Algorithm to track the GMPP under partial shading conditions - Experimental validation", Energy Conversion and Management, 2023

Publication

1 %

8

A.G. Olabi, Mohammad Ali Abdelkareem, Concetta Semeraro, Muaz Al Radi et al. "Artificial Neural Networks Applications in Partially Shaded PV Systems", Thermal Science and Engineering Progress, 2022

Publication

1 %

9

Syafaruddin, , Takashi Hiyama, and Engin Karatepe. "Investigation of ANN performance for tracking the optimum points of PV module under partially shaded conditions", 2010 Conference Proceedings IPEC, 2010.

Publication

1 %

10

Abdelhadi Raihani, Tajeddine Khalili, Mohamed Rafik, Mohammed Hicham, Omar Bouattane. "Towards a Real Time Energy Management Strategy for Hybrid Wind-PV Power System based on Hierarchical Distribution of Loads", International Journal of Advanced Computer Science and Applications, 2019

Publication

1 %

11

M. Veerachary, T. Senjyu, K. Uezato. "Feedforward maximum power point tracking of PV systems using fuzzy controller", IEEE Transactions on Aerospace and Electronic Systems, 2002

Publication

1 %

12

H Parung, N H Aswad, Tachrir. "Shear strength analysis of reduced beam section (RBS) on castellated beam", IOP Conference Series: Earth and Environmental Science, 2020

Publication

<1 %

13

Akarasate Homwiseswongsa, Chiabwoot Ratanavilisagul. "Modified Differential

<1 %

Evolution Algorithm for Solving Multi-Skill Resource-Constrained Project Scheduling Problem", 2023 15th International Conference on Information Technology and Electrical Engineering (ICITEE), 2023

Publication

14

C. K. Kwong, K. Y. Chan, M. E. Aydin, T. C. Fogarty. "An orthogonal array based genetic algorithm for developing neural network based process models of fluid dispensing", International Journal of Production Research, 2006

Publication

15

Mohammad AlShabi, Mamdouh El Haj Assad. "Artificial Intelligence applications in renewable energy systems", Elsevier BV, 2021

Publication

16

W.N. Sharpe, Mo-Yuen Chow, S. Briggs, L. Windingland. "A methodology using fuzzy logic to optimize feedforward artificial neural network configurations", IEEE Transactions on Systems, Man, and Cybernetics, 1994

Publication

17

Mummadi Veerachary, Tomonobu Senjyu, Katsumi Uezato. "Neural network-based feedforward maximum power point tracking control for IDB converter-supplied PV

<1 %

<1 %

<1 %

<1 %

system", International Journal of Electronics,
2010

Publication

18

T. Boutabba, S. Drid, L. Chrifi-Alaoui, M. Ouriagli, M.E.H. Benbouzid. "dSPACE real-time implementation of maximum power point tracking based on ripple correlation control (RCC) structure for photovoltaic system", 2016 5th International Conference on Systems and Control (ICSC), 2016

Publication

<1 %

19

Chakarajamula Hussaian Basha, Madhu Palati, C. Dhanamjayulu, S. M. Muyeen, Prashanth Venkatareddy. "A novel on design and implementation of hybrid MPPT controllers for solar PV systems under various partial shading conditions", Scientific Reports, 2024

Publication

<1 %

20

Ehsanolah Assareh, Seyed Sajad Mousavi Asl, Neha Agarwal, Mehrdad Ahmadinejad, Amin Jalali, Moonyong Lee. "A Cogeneration-Coupled Energy Storage System Utilizing Hydrogen and Methane-fueled CAES and ORC with Ambient Temperature Consideration Enhanced by Artificial Neural Network, and Multi-Objective optimization", Thermal Science and Engineering Progress, 2023

Publication

<1 %

21 Ioannis Mandourarakis, Vasiliki Gogolou, Zoi Agorastou, Stylianos Voutsinas et al. "Development of a smart photovoltaic cells system", Energy Conversion and Management, 2023
Publication

22 Koami Soulemame Hayibo, Aliaksei Petsiuk, Pierce Mayville, Laura Brown, Joshua M. Pearce. "Monofacial vs bifacial solar photovoltaic systems in snowy environments", Renewable Energy, 2022
Publication

23 Syafaruddin, , E. Karatepe, and T. Hiyama. "Controlling of artificial neural network for fault diagnosis of photovoltaic array", 2011 16th International Conference on Intelligent System Applications to Power Systems, 2011.
Publication

24 Amadou BA, Alphousseyni NDIAYE, El hadji Mbaye NDIAYE, Senghane MBODJI. "Power optimization of a photovoltaic system with artificial intelligence algorithms over two seasons in tropical area", MethodsX, 2023
Publication

25 Ramdaniah, A Lawi, S Syarif. "Performance evaluation of naive Bayes and support vector machine in type 2 Diabetes Mellitus gene

expression microarray data", Journal of Physics: Conference Series, 2019

Publication

Exclude quotes On

Exclude matches Off

Exclude bibliography On